

LED TROFFER

CCT AND WATT CHANGING

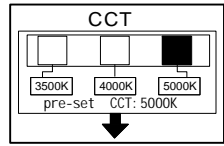

CCT CHANGING: 3500K/4000K/5000K



WATT SWITCH

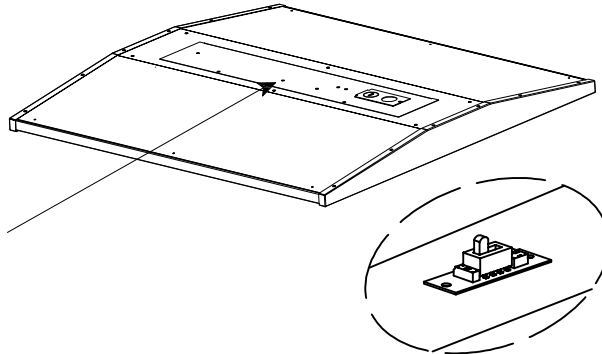

Installation manual

A.T-Grid ceilings installation

Step1

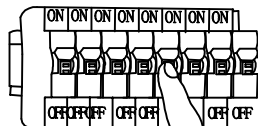

OFF

Turn off the switch

Step2

Remove the ceiling (s) at an appropriate location where the light fixture is to be installed.

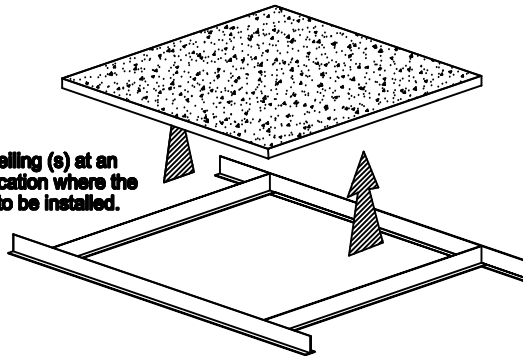

Step3

Power Leads Connection
Remove screw holding access cover plate and remove the necessary knockout

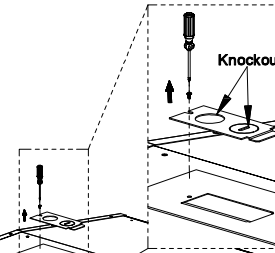

Step4 Turn off the power and wiring by using wire nuts.

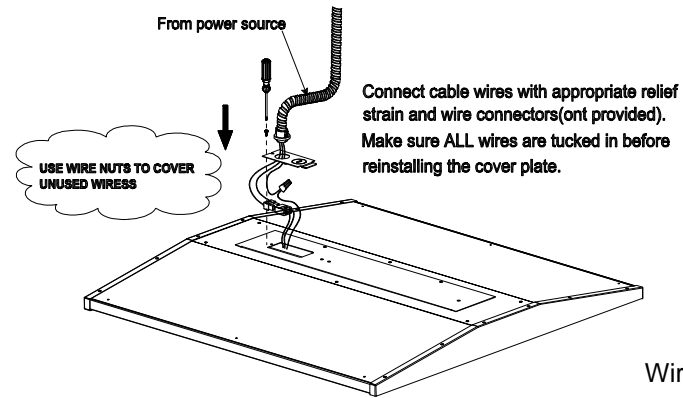

Wiring Diagram

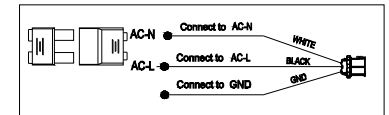

Step5

